

Fig. 1

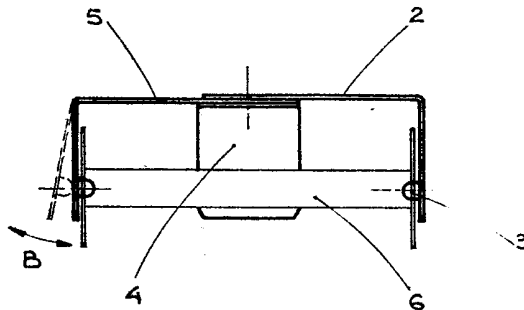

Fig. 2